



X3 Series User Manual

8.0kW - 15.0kW



EN



Solax Power Network Technology(Zhe jiang) Co., Ltd.

No.288 Shizhu Road, Tonglu Economic Development Zone,
Tonglu City, Zhejiang province, China.

Tel: +86 0571-56260011

E-mail: info@solaxpower.com

Copyright Declaration

The copyright of this manual belongs to Solax Power Network Technology(Zhe jiang) Co., Ltd.. Any corporation or individual should not plagiarize, partially or fully copy (including software,etc.), and no reproduction or distribution of it in any form or by any means. All rights reserved. Solax Power Network Technology (Zhe jiang) Co.,Ltd.. reserves the right of final interpretation.

Contents

1 Note on this Manual	03
1.1 Scope of Validity	03
1.2 Target Group	03
1.3 Symbols Used	03
2 Safety	04
2.1 Appropriate Usage	04
2.2 Important Safety Instructions	06
2.3 Explanation of Symbols	08
2.4 EC Directives	09
3 Introduction	11
3.1 Basic Features	11
3.2 Terminals of Inverter.....	11
3.3 Dimension	12
4 Technical Data	13
4.1 DC Input	13
4.2 AC Output	13
4.3 Efficiency, Safety and Protection.....	14
4.4 General Data	14
5 Installation	15
5.1 Check for Transport Damage	15
5.2 Packing List	15
5.3 Installation Precaution	16
5.4 Installation Steps	17
5.5 Connection of the Inverter.....	18
5.6 Run the Inverter	28
6 Operation Method	29
6.1 Control Panel.....	29
6.2 LCD Function	30
6.3 LCD Operation	31

7 Troubleshooting 40

7.1 Trouble Shooting 40

7.2 Routine Maintenance 43

8 Decommissioning 44

8.1 Dismantling the Inverter 44

8.2 Packaging 44

8.3 Storage and Transportation 44

1 Notes on this Manual

1.1 Scope of Validity

This manual is an integral part of X3 Series, It describes the assembly, installation, commissioning, maintenance and failure of the product. Please read it carefully before operating.

X3-8.0P-T-D **X3-8.0P-T-N**
X3-10.0P-T-D **X3-10.0P-T-N**
X3-12.0P-T-D **X3-12.0P-T-N**
X3-15.0P-T-D **X3-15.0P-T-N**

Note: **"8.0"** means 8.0kW. **"T"** means "dual" MPPT strings. MPPT. **"D"** means with "DC Switch", **"N"** means without "DC Switch". **"P"** means MIC PRO series.

Keep this manual at where is accessible all the time.

1.2 Target Group

This manual is for qualified electricians. The tasks described in this manual only can be performed by qualified electricians.

1.3 Symbols Used

The following types of safety instructions and general information appear in this document as described below:



Danger!
 "Danger" indicates a hazardous situation which, if not avoided, will result in death or serious injury.



Warning!
 "Warning" indicates a hazardous situation which, if not avoided, could result in death or serious injury.



Caution!
 "Caution" indicates a hazardous situation which, if not avoided, could result in minor or moderate injury.



Note!
 "Note" provides tips that are valuable for the optimal

2 Safety

2.1 Appropriate Usage

The X3 Series are PV inverters which can convert the DC current of the PV generator into AC current and feed it into the public grid.

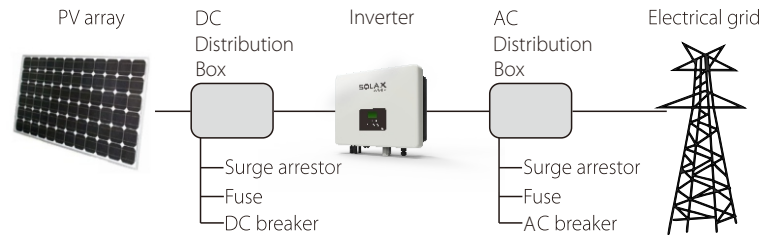

figure1

► Surge protection devices (SPDs) for PV installation

WARNING !

Over-voltage protection with surge arresters should be provided when the PV power system is installed. The grid connected inverter is fitted with SPDs in both PV input side and MAINS side.

Lightning will cause a damage either from a direct strike or from surges due to a nearby strike.

Induced surges are the most likely cause of lightning damage in majority of installations, especially in rural areas where electricity is usually provided by long overhead lines. Surge may be included on both the PV array conduction and the AC cables leading to the building.

Specialists in lightning protection should be consulted during the end use application. Using appropriate external lightning protection, the effect of a direct lightning strike into a building can be mitigated in a controlled way, and the lightning current can be discharged into the ground.

Installation of SPDs to protect the inverter against mechanical damage and excessive stress include a surge arrester in case of a building with external lightning protection system (LPS) when separation distance is kept.

To protect the DC system, Surge Protection Device (SPD type2) should be fitted at the inverter end of the DC cabling and at the array located between the inverter and the PV generator, if the voltage protection level (VP) of the surge arresters is greater than 1100V, an additional SPD type 3 required surge protection for electrical devices.

To protect the AC system, surge suppression devices (SPD type2) should be fitted at the main incoming point of AC supply (at the consumer's cutout), located between the inverter and the meter/distribution system; SPD (test impulse D1) for signal line according to EN 61632-1.

All DC cables should be installed to provide as short a run as possible, positive and negative cables of the string or main DC supply should be bundled together. Avoiding the creation of loops in the system. This requirement for short runs and bundling includes any associated earth bundling conductors.

Spark gap devices are not suitable to be used in DC circuits once conducting, they won't stop conducting until the voltage across their terminals is typically more than 30 volts.

► Anti-Islanding Effect

Islanding effect is a special phenomenon that grid-connected PV system still supply power to the nearby grid when the voltage loss happened in the power system. It is dangerous for maintenance personnel and the public.

X3 series provide Active Frequency Drift (AFD) to prevent islanding effect.

2.2 Important Safety Instructions



Danger!

Danger to life due to high voltages in the inverter!

- All work must be carried out by qualified electrician.
- The appliance is not to be used by children or persons with reduced physical sensory or mental capabilities, or lack of experience and knowledge, unless they have been given supervision or instruction.
- Children should be supervised to ensure that they do not play with the appliance.



Caution!

Danger of burn injuries due to hot enclosure parts!

- During operation, the upper lid of the enclosure and the enclosure body may become hot.
- If necessary, touch the lower temperature enclosure lid during operation.



Caution!

Possible damage to health as a result of the effects of radiation!

- Do not stay closer than 20 cm to inverter for any length of time.



Note!

Grounding the PV generator.

- Comply with the local requirements for grounding the PV modules and the PV generator. SolaX recommends connecting the generator frame and other electrically conductive surfaces in order to ensure continuous conduction and ground.



Warning!

- Ensure input DC voltage \leq Max. DC voltage. Over voltage may cause permanent damage to inverter or other losses, which will not be included in warranty!



Warning!

- Authorized service personnel must disconnect both AC and DC power from X3 series before attempting any maintenance or cleaning or working on any circuits connected to the X3 series.



WARNING !

Do not operate the inverter when the device is running.



WARNING !

Risk of electric shock!

- Prior to the application, please read this section carefully to ensure correct and safe application. Please keep the user manual properly.
- Use only attachments recommended or sold by SolaX. Otherwise may result in a risk of fire, electric shock, or injury to person.
- Make sure that existing wiring is in good condition and that wire is not undersized.
- Do not disassemble any parts of inverter which are not mentioned in installation guide. It contains no user-serviceable parts. See Warranty for instructions on obtaining service. Attempting to service the X3 Series inverter yourself may result in a risk of electric shock or fire and will void your warranty.
- Keep away from flammable, explosive materials to avoid fire disaster.
- The installation place should be away from humid or corrosive substance.
- Authorized service personnel must use insulated tools when installing or working with this equipment.
- PV modules shall have an IEC 61730 class A rating.
- Never touch either the positive or negative pole of PV connecting device. Strictly prohibit touching both of them at the same time.
- The unit contains capacitors that remain charged to a potentially lethal voltage after the MAINS and PV supply have been disconnected.
- Hazardous voltage will present for up to 5 minutes after disconnection from power supply.
- CAUTION-RISK of electric shock from energy stored in capacitor,. Never operate on the solar inverter couplers, The MAINS cables, PV cables or the PV generator when power is applied. After switching off the PV and Mains, always wait for 5minutes to let the intermediate circuit capacitors discharge before you unplug DC and MAINS couplers.
- When accessing the internal circuit of solar inverter, it is very important to wait 45minutes before operating the power circuit or demounting the electrolyte capacitors inside the device. Do not open the device before hand since the capacitors require time to sufficiently discharge!
- Measure the voltage between terminals UDC+ and UDC- with a multi-meter (impedance at least 1Mohm) to ensure that the device is discharged before beginning work (35VDC) inside the device.

PE Connection and Leakage Current

- All inverters incorporate a certified internal Residual Current Device(RCD) in order to protect against possible electrocution and fire hazard in case of a malfunction in the PV array, cables or inverter. There are 2 trip thresholds for the RCD as required for certification (IEC 62109-2:2011). The default value for electrocution protection is 30mA, and for slow rising current is 300mA.
- If an external RCD is required by local regulations, check which type of RCD is required for relevant electric code. It recommends using a type-A RCD. The recommended RCD values is 100mA or 300mA unless a lower value is required by the specific local electric codes. When required by local regulations, the use of an RCD type B is permitted.

	WARNING ! High leakage current! Earth connection essential before connecting supply.
---	---

- Incorrect grounding can cause physical injury, death or equipment malfunction and increase electromagnetic.
- Make sure that grounding conductor is adequately sized as required by safety regulations.
- Do not connect the ground terminals of the unit in series in case of a multiple installation. This product can cause current with a d.c component, Where a residual current operated protective (RCD) or monitoring (RCM) device is used for protection in case of direct or indirect contact, only an RCD or RCM of type B is allowed on the supply side of this product.

For United Kingdom

- The installation that connects the equipment to the supply terminals shall comply with the requirements of BS 7671.
- Electrical installation of PV system shall comply with requirements of BS 7671 and IEC 60364-7-712.
- No protection settings can be altered.
- User shall ensure that equipment is so installed, designed and operated to maintain at all times compliance with the requirements of ESQCR22(1)(a).



For Australia and New Zealand

- Electrical installation and maintenance shall be conducted by licensed electrician and shall comply with Australia National Wiring Rules.











2.3 Explanation of Symbols

This section gives an explanation of all the symbols shown on the inverter and on the type label.

• Symbols on the Inverter

Symbol	Explanation
	Operating Display.
	Communication is active.
	An error has occurred, please inform your installer immediately.

• Symbols on the Type Label

Symbol	Explanation
	CE mark. The inverter complies with the requirements of the applicable CE guidelines.
	RCM remark.
	SAA certification.
	Beware of hot surface. The inverter can become hot during operation. Avoid contact during operation.
	Danger of high voltages. Danger to life due to high voltages in the inverter!
	Danger. Risk of electric shock!
	Observe enclosed documentation.
	The inverter can not be disposed together with the household waste. Disposal information can be found in the enclosed documentation.
	Do not operate this inverter until it is isolated from mains and on-site PV generation suppliers.
	Danger to life due to high voltage. There is residual voltage in the inverter which needs 5 min to discharge. • Wait 5 min before you open the upper lid or the DC lid.
	RoHS certificate The inverter complies with the requirements of Restriction of Hazardous Substances.

2.4 CE Directives

This chapter follows the requirements of the European low voltage directives, which contains the safety instructions and conditions of acceptability for the end user system, which you must follow when installing, operating and servicing the unit. If ignored, physical injury or death may follow, or damage may occur to the unit. Read this instructions before you work on the unit. If you are unable to understand the dangers, warnings, cautions or instructions, please contact an authorized service dealer before installing. Operating and servicing the unit.

The Grid connected inverter meets the requirement stipulated in Low Voltage Directive (LVD) 2014/35/EU and Electromagnetic Compatibility (EMC) Directive 2014/30/EU. The unit is based on:

EN 62109-1:2010 ; EN 62109-2:2011 ; IEC 62109-1(ed.1) ; IEC62109-2(ed.1)

EN 61000-6-3:2007+A:2011 ; EN 61000-6-1:2007 ; EN 61000-6-2:2005

In case of installation in PV system, startup of the unit (i.e. start of designated operation) is prohibited until it is determined that the full system meets the requirements stipulated in EC Directive (2014/35/EU,2014/30/EU, etc.)

The grid connected inverter leave the factory completely connecting device and ready for connection to the mains and PV supply ,the unit shall be installed in accordance with national wiring regulations. Compliance with safety regulations depends upon installing and configuring system correctly, including using the specified wires. The system must be installed only by professional assemblers who are familiar with requirements for safety and EMC. The assembler is responsible for ensuring that the end system complies with all the relevant laws in the country where it is to be used.

The individual subassembly of the system shall be interconnected by means of the wiring methods outlined in national/international such as the national electric code (NFPA) No.70 or VDE regulation 0107.

3. Introduction

3.1 Basic features

Thanks for your purchasing with SolaX X3 Serial inverter. The X3 Series inverter is one of the finest inverters on the market today, incorporating state-of-the-art technology, high reliability, and convenient control features.

- Advanced DSP control technology.
- Utilize the latest high-efficiency power component.
- Optimal MPPT technology.
 - Two independent MPP Tracking.
 - Wide MPPT input range.
- Advanced anti-islanding solutions.
- IP65 protection level.
- Max. efficiency up to 98.3%.EU efficiency up to 97.8%.
- THD<3%.
- Safety &Reliability: transformerless design with software and hardware protection.
- Export control.
- Power factor regulation.
- Friendly HMI.
 - LED status indications.
 - LCD display technical data, Human-machine interaction through press key.
 - PC remote control.
 - Upgrade through USB interface.
 - Pocket Wi-Fi/Lan monitoring.
 - Control loads' switch intelligently by RF.
 - Energy conservation.

3.2 Terminals of inverter

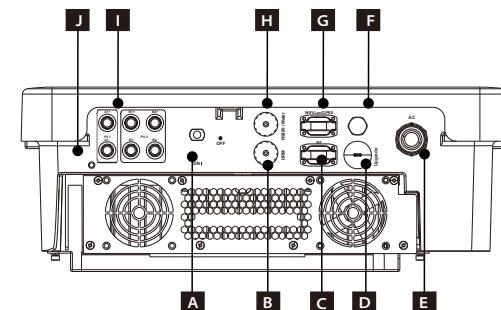

Object	Description
A	DC Switch (optional)
B	DRM
C	Smart plug (optional)
D	USB for Upgrade
E	AC Connector
F	Waterproof plug
G	Pocket WiFi/Lan/GPRS (all optional)
H	RS 485/ Meter(optional)
I	PV Connector
J	Ground screw

**Warning!**

Only authorized personnel is allowed to set the connection.

3.3 Dimension

➤ Dimension

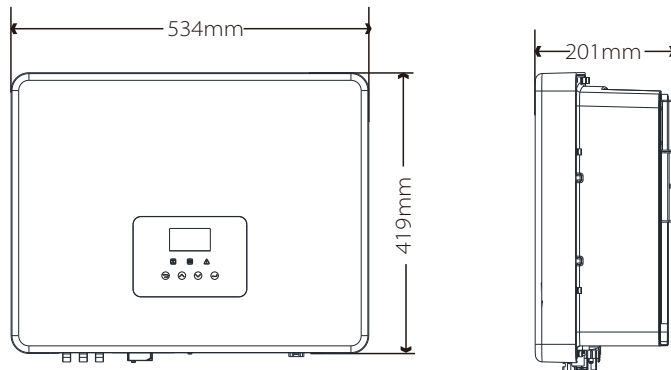

4. Technical Data

4.1 DC input

Model	X3-8.0P-T-D	X3-10.0P-T-D	X3-12.0P-T-D	X3-15.0P-T-D
	X3-8.0P-T-N	X3-10.0P-T-N	X3-12.0P-T-N	X3-15.0P-T-N
Max. recommended DC power [W]	A:3200/B:6400	A:4000/B:8000	A:4800/B:9600	A:6000/B:12000
Max. DC voltage[V]	1000	1000	1000	1000
Normalinal DC operating voltage[V]	600	600	600	600
Operating voltage range [V]	160-950	160-950	160-950	160-950
MPPT voltage range@full load [V]	282-800	349-800	416-800	516-800
Max. input current [A]	10/20	10/20	10/20	10/20
Max. short circuit current [A]	12/24	12/24	12/24	12/24
Start up voltage [V]	140	140	140	140
Start output voltage [V]	180	180	180	180
No. of MPP trackers	2	2	2	2
Strings per MPP tracker	A:1/B:2	A:1/B:2	A:1/B:2	A:1/B:2
DC disconnection switch	optional			
Max. inverter backfeed current to the array(mA)	0			

4.2 AC output

Model	X3-8.0P-T-D	X3-10.0P-T-D	X3-12.0P-T-D	X3-15.0P-T-D
	X3-8.0P-T-N	X3-10.0P-T-N	X3-12.0P-T-N	X3-15.0P-T-N
Rated output power [W]	8000	10000	12000	15000
Max.apparent AC power [VA]	8000	10000	12000	15000
Rated grid voltage and range [V]	3/N/PE,230/400 (310-480)			
Rated AC frequency and range [Hz]	50(45-55)/60(55-65)			
Normal AC current [A]	11.6	14.5	17.4	21.7
Max. output current [A]	12.8	16.0	19.2	23.8
Max. output fault current [A]	28.3			
Max. output overcurrent protection(A)	38			
Inrush current(A)	50			
THD	<3%			
Displacement power factor	0.8 leading-0.8lagging			
Feed in phase	three-phase			

4.3 Efficiency, Safety and Protection

Model	X3-8.0P-T-D	X3-10.0P-T-D	X3-12.0P-T-D	X3-15.0P-T-D
	X3-8.0P-T-N	X3-10.0P-T-N	X3-12.0P-T-N	X3-15.0P-T-N
MPPT efficiency	99.90%	99.90%	99.90%	99.90%
Euro efficiency	97.80%	97.80%	97.80%	97.80%
Max. efficiency	98.30%	98.30%	98.30%	98.30%
Safety & Protection				
Over/under voltage protection	YES			
DC isolation protection	YES			
Monitoring ground fault protection	YES			
Grid protection	YES			
DC injection monitoring	YES			
Back feed current monitoring	YES			
Residual current detection	YES			
Anti-islanding protection	YES			
Over load protection	YES			
Over heat protection	YES			

4.4 General Data

Model	X3-8.0P-T-D	X3-10.0P-T-D	X3-12.0P-T-D	X3-15.0P-T-D
	X3-8.0P-T-N	X3-10.0P-T-N	X3-12.0P-T-N	X3-15.0P-T-N
Dimension [W/H/D](mm)	534*419*201			
Dimension of packing [W/H/D](mm)	600*540*300			
Net weight [kg]	30	30	30	30
Gross weight [kg]	35	35	35	35
Installation	Wall-mounted			
Operating temperature range[°C]	-25~+60 (derating at 45)			
Storage temperature [°C]	-25~+60			
Storage/Operation relative humidity	0%~100%, condensation			
Altitude [m]	<2000			
Ingress Protection	IP65			
Isolation type	Transformerless			
Protective Class	I			
Night-time consumption	<3w			
Over Voltage Category	III (MAINS), II (PV)			
Pollution Degree	II			
cooling	Forced airflow			
Noise level	<45dB			
Communication interface	WiFi(optional)/Lan(optional)/GPRS (optional)/Meter(optional)/ RF(optional)/ USB/ DRM/RS485			
Standard warranty [year]	5 (10 optional)			

5. Installation

5.1 Check for Transport Damage

Make sure the inverter is intact during transportation. If there are some visible damages, such as cracks, please contact your dealer immediately.

5.2 Packing List

Open the package and fetch out the product, check the accessories at first. The packing list shows as below.

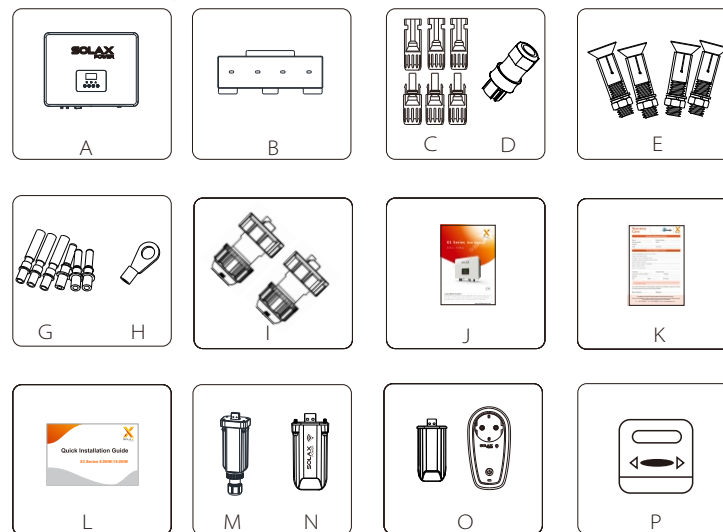

Object	Quantity	Description
A	1	X3 series inverter
B	1	Bracket
C	6	DC connector
D	1	AC connector
E	4	Expansion bolt
G	6	DC pin contact(3*positive, 3*negative)
H	1	Earth terminal
I	2(For AU) 1(For EN)	Waterproof connector with RJ45
J	1	Product manual
K	1	Warranty card
L	1	Quick installation guide
M	1	Pocket Lan(Optional)
N	1	Pocket WiFi(Optional)
O	1	RF(Optional)
P	1	Meter(Optional)

5.3 Installation Precaution

X3 Series inverter is designed for outdoor installation (IP 65). Make sure the installation site meets the following conditions:

- Not in direct sunlight.
- Not in areas where highly flammable materials are stored.
- Not in potential explosive areas.
- Not in the cool air directly.
- Not near the television antenna or antenna cable.
- Not higher than altitude of about 2000m above sea level.
- Not in environment of precipitation or humidity
- Be sure the ventilation is good enough.
- The ambient temperature in the range of -25°C to +60°C.
- The slope of the wall should be within $\pm 5^\circ$.
- The wall hanging the inverter should meet conditions below:
 1. solid brick/concrete, or strength equivalent mounting surface;
 2. Inverter must be supported or strengthened if the wall's strength isn't enough (such as wooden wall, the wall covered by thick layer of decoration)

Please avoid direct sunlight, rain exposure, snow laying up during installing and operating.

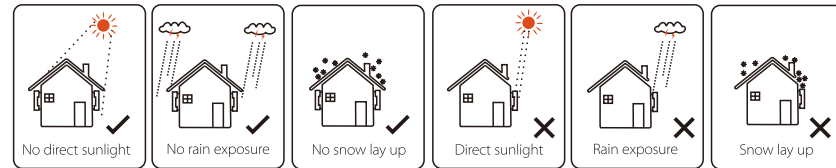

➤ Available Space Size

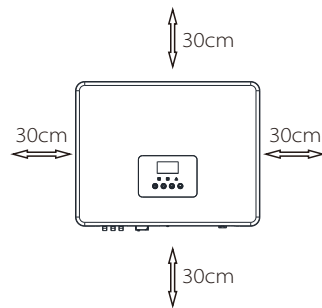

Table Available Space Size

Position	Min.size
Left	30cm
Right	30cm
Top	30cm
Bottom	30cm
Front	30cm

5.4 Installation Steps

➤ Preparation

Below tools are needed before installation.



Installation tools : crimping pliers for binding post and RJ 45, screwdriver, manual wrench and $\phi 6$ drill.

➤ Step 1: Screw the wall bracket on the wall

- a) Use the wall bracket as a template to mark the position of the 4 holes on the wall.
- b) Drill holes with driller, make sure the holes are deep enough (at least 60mm) for installation, and then tighten the expansion tubes.
- c) Install the expansion tubes in the holes, and tighten them. Then install the wall bracket by using the expansion screws.

➤ Step 2: Match the inverter with wall bracket

- d) Hang the inverter over the bracket, move the inverter close to it, slightly lay down the inverter, and make sure the 4 mounting bars on the back are fixed well with the 4 grooves on the bracket.

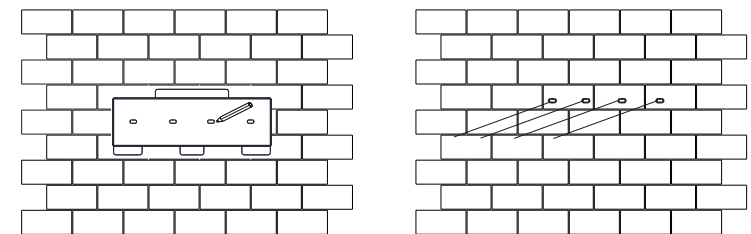

a)

b)

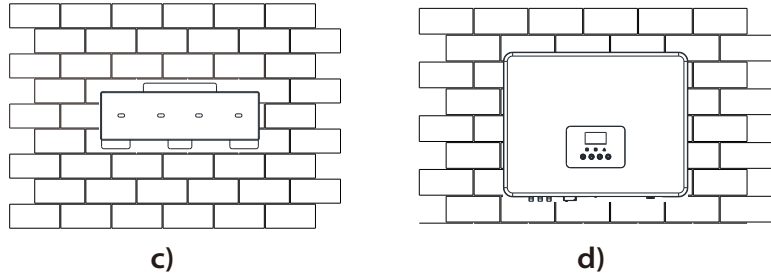

5.5 Connection of the Inverter

5.5.1 The Main Steps to Connect to the Inverter

➤ PV String Connection

X3 series inverter have three couples PV connectors which can be connected in series into 3-strings PV modules. Please select PV modules with excellent function and reliable quality. Open circuit voltage of module array connected should be < Max.DC (table as follow) input voltage, and operating voltage should be within the MPPT voltage range.

Table 3 Max. DC Voltage Limitation

Model	X3-8.0P-T-D	X3-10.0P-T-D	X3-12.0P-T-D	X3-15.0P-T-D
	X3-8.0P-T-N	X3-10.0P-T-N	X3-12.0P-T-N	X3-15.0P-T-N
Max.DC Voltage	1000V			



Danger!

Danger to life due to high voltage on DC conductors. when exposed to sunlight, the pv array generates dangerous DC voltage which is present in the DC conductors. Touching the DC conductors can lead to lethal electric shocks. Cover the PV modules. Do not touch the DC conductors.



Note!

Please choose a suitable external DC switch if the model (X3-8.0P-T-N, X3-10.0P-T-N, X3-12.0P-T-N, X3-15.0P-T-N) is purchased.



Warning!

PV module voltage is very high which belongs to dangerous voltage range, please comply with the electric safety rules when connecting.



Warning!

Please do not make PV positive or negative ground!



Note!

Please follow the requirements of PV modules as below: Same type; Same quantity; Identical alignment; Identical tilt. In order to save cable and reduce the DC loss, we suggest installing the inverter near PV modules.

● Connection Steps

- a) Turn off the DC switch.
- b) Choose 12 AWG wire to connect the PV module.
- c) Strip 6mm of insulation from the wire end.
- d) Separate the DC connector as below.

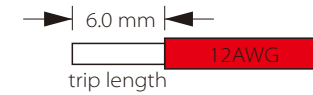

- d) Separate the DC connector as below.

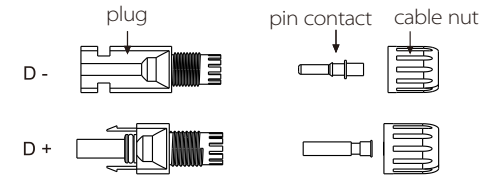

- e) Insert striped cable into pin contact and ensure all conductor strand are captured in the pin contact.
- f) Crimp pin contact by using a crimping pliers. Put the pin contact with striped cable into the corresponding crimping pliers and crimp the contact.

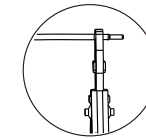

- g) Insert pin contact through the cable nut to assemble into back of the male or female plug. When you feel or heard a "click" the pin contact assembly is seated correctly. (torque: 1.2 ± 0.1 Nm)

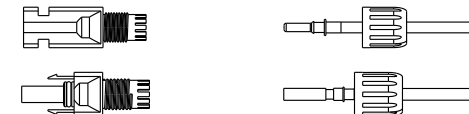

➤ **Grid Connection**

X3 series inverter are designed for three phase grid. Rated grid voltage is 230V, frequency is 50/60Hz. Other technical requests should comply with the requirement of the local public grid.

Table 4 Cable and Micro-breaker recommended

Model	X3-8.0P-T-D X3-8.0P-T-N	X3-10.0P-T-D X3-10.0P-T-N	X3-12.0P-T-D X3-12.0P-T-N	X3-15.0P-T-D X3-15.0P-T-N
Cable	5mm ²	≥6mm ²	≥6mm ²	≥6mm ²
Micro-breaker	20A	25A	32A	32A

*The parameters have some differences because of different environment and material. Please according to the local conditions to choose appropriate cable and micro-breaker.

Micro-breaker should be installed between inverter and grid, any loads should not be connected with inverter directly.

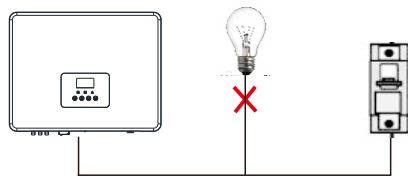

Incorrect Connection between Load and Inverter

• **Connection Steps**

- Check the grid voltage and compare with the permissive voltage range (refer to technical data).
- Disconnect the circuit-bricker from all the phases and secure against re-connection.
- Trip the wires:
 - Trip all the wires to 52.5mm and the PE wire to 55mm.
 - Use the crimping pliers to trip 12mm of insulation from wire ends as below.

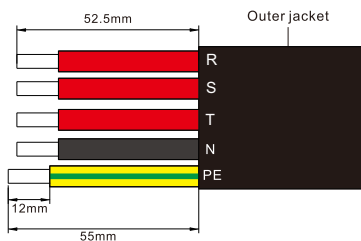

- Separate the AC plug into three parts as below.
 - Hold the middle part of the female insert, rotate the back shell to loose it, and detach it from female inset.
 - Remove the cable nut (with rubber insert) from the back shell.

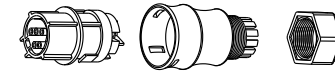

- Slide the cable nut and then back shell onto the cable.

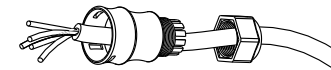

- Insert the tripped end of each five wires into the appropriate hole in the female insert, and then tight each screw (to tight each wire in place). (PH1 cross screwdriver .torque:0.8±0.1Nm)

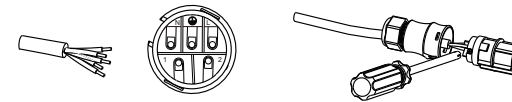

- Screw down the threaded sleeve the pressure screw.

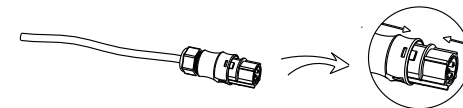

- Screw down the pressure screw.(torque:3±0.3Nm)

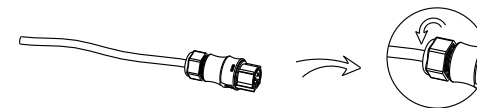

- Connect the AC plug to the inverter.

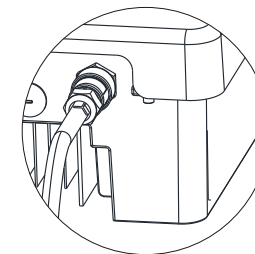

Selection of Fuses and Cables

Main cable(AC line cable)shall be short circuit protected and thermal overload protected.

Always fit the input cable with fuse. Normal gG(US:CC or T)fuses will protect the input cable in short circuit situation. They will also prevent damage to adjoining equipment.

Dimension the fuses according to local safety regulations, appropriate input voltage and the related current of the solar inverter.

AC output protected by external fuse(gG rated current 20A/600VAC for 8.0KW ; 25A/600VAC for 12.0KW;32A/600VAC for 12.0KW;32A/600VAC for 15.0KW) provides in all live connections to the AC supply.

The rated short circuit breaking capacity of the above protective device shall be at least equal to the prospective fault current at the point of installation. See section technical data of this manual details.

AC output cable: Cu; R,S,T, N+PE: 3*5.0mm²+5.0mm² for 8.0KW and 2*6.0mm²+6.0mm² for 10.0KW/12.0KW/15.0KW @40°C ambient temperature with a max length of 5m, with operating time of the fuses is less than 5 seconds, installation method B2 according to EN60204-1:2006, annex D: cable in conduit cable trunking system, number of loaded circuit only one. Use H07RNF(cord designation 60245 IEC66) for an ambient temperature of 40°C or less and use 90°C wire for ambient temperature between 40°C and 60°C.

Note 1: For condition differing from those mentioned above, dimension the cables according to local safety regulations, appropriate input voltage and the load and the load current of the unit.(You can choose a thicker cable but the fuses must rated according to the cable.)

Note 2: Fuses must be approved by Notified Body.

Therefore the current-carrying capacity of the components and sub-assemblies provided in the end-use system(connectors, cables, junction box, switch ger, etc.) and the reverse current PV modules shall be considered based on the feedback current and reverse current. The direct current(DC) circuit breaker or fuse between each solar generator and inverter shall be provided based on solar inverter input ratings.

Select DC cables based in the above inverter back-feed current and ISC PV rating and Vmax ratings.

➤ Earth Connection

Screw the ground screw with screwdriver shown as follow. (ϕ 4 hexagon wrench.torque:1.5±0.2Nm)

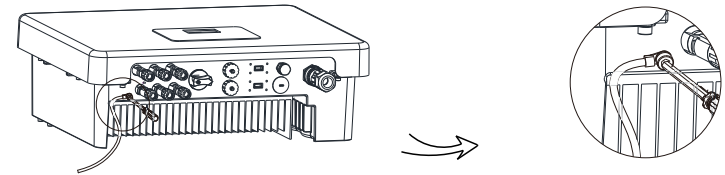

5.5.2 Communication interface

This product has a series of communication interfaces: such as WIFI/LAN/GPRS, RF, RS485/Meter, DRM and USB for upgrading for human and machine communication. Operating information like output voltage, current, frequency, faulty information, etc., can be delivered to PC or other monitoring equipment via these interfaces.

① WiFi/Lan/GPRS(Optional)

This inverter provides a WiFi/Lan port which can collect information from inverter including status, performance and updating information to monitoring website via connecting Pocket WiFi/Pocket Lan(purchase the product from supplier if needed)

Connection steps:

Please check the Pocket WiFi user manual for more details.(torque:0.6±0.1Nm)

② RF(Optional)

The inverter provides a RF(radio frequency) interface which can make a load be switched or operated in a specified duration via connecting an external Smart plug(purchase the product from supplier if needed.) so that the load mostly consumes PV energy and incurs the lowest-possible energy costs during operation.

Please check the Smart Plug user manual for the detail of connection steps.

③ RS 485/Meter

a. RS 485

This is a communication interface provided for engineer to adjust the inverter.

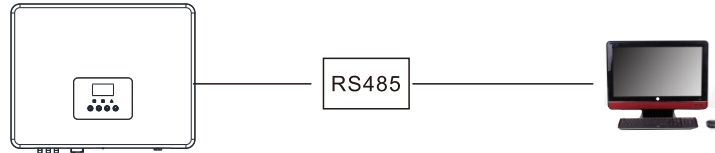

b. Meter(optional)

A meter can communicate with the X3 series inverter through this interface, then you can:

1. Monitor the energy to grid and from grid throughout the whole day.
2. Achieve the export control function with a higher accuracy.

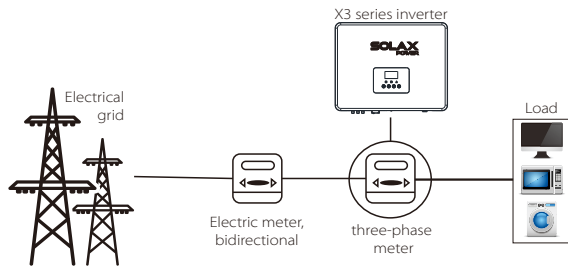

The PIN definitions of RS 485/Meter interface are as below.

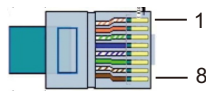

PIN	1	2	3	4	5	6	7	8
Definition	X	X	X	485_A	485_B	X	METER 485_A	METER 485_B

RS 485 Connection Steps:

1. Prepare RJ45 connector and a communication cable.
2. Trip the insulation from the communication cable.
3. Let the communication cable pass through the waterproof connector with RJ45, then insert it into the RJ45 connector following the PIN definition rule.

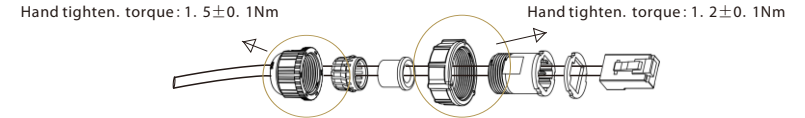

4. Crimp the RJ45 connector with the crimping plier.
5. Insert the cable into the RS 485/Meter port of the inverter, and tighten the waterproof connector.

Meter Connection Steps:

Please see the Quick Guide for three-Phase Meter Installation for details.

④ DRM

DRM is provided to support several demand response modes by giving control signals as below.

Pin	1	2	3	4	5	6	7	8
Definition	DRM1/5	DRM2/6	DRM3/7	DRM4/8	+3.3V_COM	DRM0	GND	GND

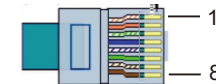

Connection Steps:

1. Prepare RJ45 connector and a communication cable.
2. Trip the insulation from the communication cable.
3. Let the communication cable pass through the waterproof plug, then insert it into the RJ45 connector following the PIN definition rule.
4. Crimp the RJ45 connector with the crimping plier.
5. Insert the cable into the DRM port of the inverter, and tighten the waterproof plug.

⑤ Upgrade

User can update the inverter system through an U-disk.



Warning!

Make sure the input voltage is more than 140V (in good illumination condition), or it may result in failing during updating.

Upgrade Steps:

1) Please contact our service support to get the update file, and extract it into your U-disk as the following file path:

"update\ARM\618.00124.00_MIC_Pro_ARM_Vx.xx_XXXXXXX.usb";
 "update\DSP\618.00103.00_MIC_DSP_Vx.xx_XXXXXXX.hex".

Note: Vx.xx is version number, XXXXXXX is file completion dates.



Warning!

Make sure the directory is in accordance with above form strictly! Do not modify the program file name ! Or it may cause the inverter not work anymore !

2) Make sure the DC switch is off and the AC is disconnected with grid. Unscrew the waterproof lid of Upgrade port by straight screwdriver as below.

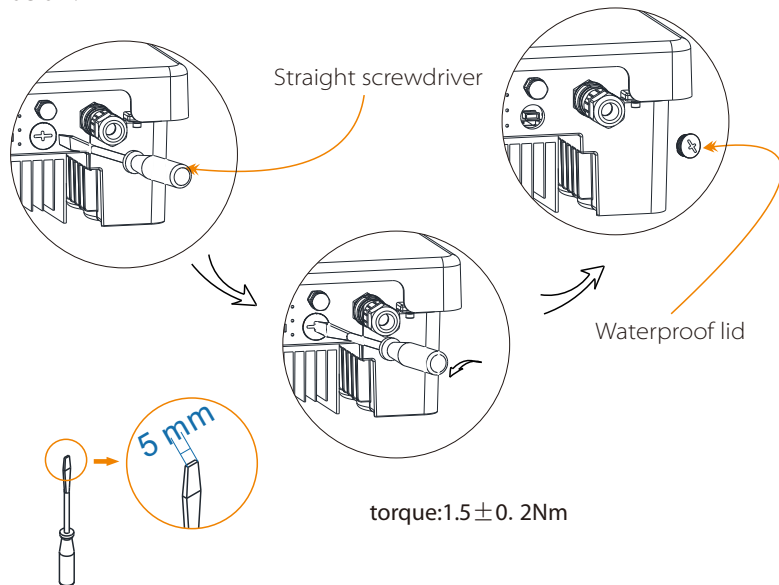

3) then insert U-disk into the USB port on the bottom of the inverter. Then turn on DC switch or connect the PV connector, the LCD will show picture as below.

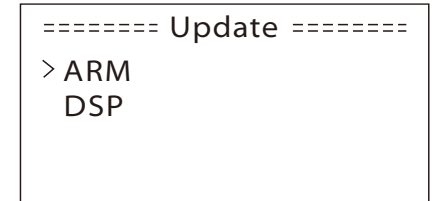
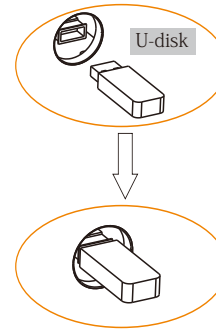

4) Press up and down to select the one that you want to update and press "OK" to confirm to update.

5) After the upgrade is complete, please pull off the U-disk, screw the waterproof lid.



Warning!

During updating, don't turn off the DC switch or disconnect the PV connector, if the updating is stopped due to PV power failure, do not unplug the U-disk until the PV power comes, update will continue. If the updating is stopped due to other reasons, reinsert the usb drive to continue the update.

5.6 Run the inverter

Start inverter after checking all below steps:

- Check that device is fixed well on the wall.
- Make sure all the DC breakers and AC breakers are disconnected.
- AC cable is connected to grid correctly.
- All PV panels are connected to inverter correctly, DC connectors which are not used should be sealed by cover.
- Turn on the external AC and DC connectors.
- Turn on the DC switch to the "ON" position.

Start inverter

- Inverter will start automatically when PV panels generate enough energy.
- Check the status of LED indication and LCD screen, the LED indication should be blue and the LCD screen should display the main interface.
- If the LED indication is not blue, please check the below:
 - All the connections are right.
 - All the external disconnect switches are closed.
 - The DC switch of the inverter is in the "ON" position.

Below is the three different states when operating, which means inverter starting up successfully.

Waiting: Inverter is waiting to checking when DC input voltage from panels is greater than 140V(lowest start-up voltage) but less than 180V(lowest operating voltage).

Checking: Inverter will check DC input environment automatically when DC input voltage from the PV panels exceeds 180V and PV panels have enough energy to start inverter.

Normal: Inverter begins to operate normally with blue light on. Meanwhile feedback energy to grid, LCD displays present output power.

Enter the setting interface to follow the instructions when it is first time to start up.



Warning!

Power to the unit must be turned on only after installation work has been completed. All electrical connections must be carried out by qualified personnel in accordance with legislation in force in the country concerned.



Note!

Please set the inverter if it is the first time to start up.

Above steps are for the regular start of the inverter. If it is the first time to start up the inverter, you need to setup the inverter.

6. Operation Method

6.1 Control panel

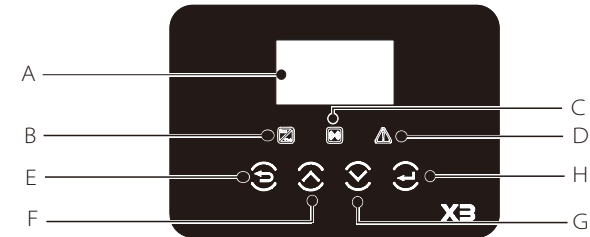

Object	Name	Description
A	LCD Screen	Display the information of the inverter.
B	Indicator LED	Blue:The inverter is in normal state.
C		Yellow:The inverter is in communication.
D		Red:The inverter is faulty.
E	Function Button	ESC button: Return from current interface or function.
F		Up button: Move cursor to upside or increase value.
G		Down button: Move cursor to downside or decrease value.
H		OK button: Confirm the selection.

6.2 LCD Function

Menu structure

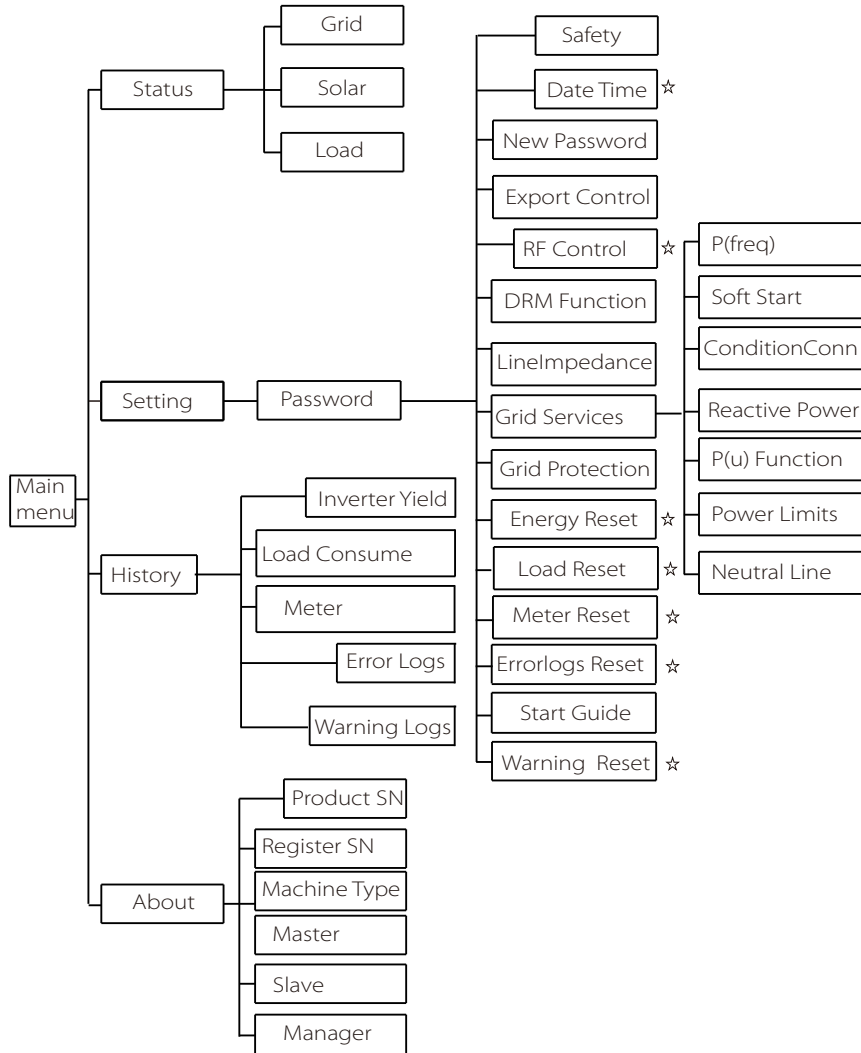

Note: "☆" Can be set by the end user.
Others can only be set by the technical or the installer with the installer password.

6.3 LCD Operation

● LCD Digital Display

The main interface is the default interface, the inverter will automatically jump to this interface when the system started up successfully or not operated for a period of time.

The information of the interface is as below. "Power" means the timely output power; "Pgrid" means the power export to or import from the grid."Today" means the power generated within the day. "Normal" shows the status of the inverter.

Power	0W
Pgrid	0W
Today	00.0KWh
Normal	

● Menu interface

The menu interface is a transfer interface for user to get into other interface to finish the setting or getting the information.

-User can get into this interface by pressing "OK" button when LCD displays the main interface.

-User can select interface by moving the cursor with function button, and press "OK" to confirm.

= = = Menu = = =
Status
> Settings
History

● Status

The status function contains three aspects of the inverter, grid, solar and load.

Press up and down to select and press "OK" to confirm the selection, press "ESC" to return to Menu.

= = = Status = = =
> Grid
Solar
Load

a) Grid

This status shows the current grid condition such as voltage, current, output power and grid power. Pout measures the output of the inverter, Pgrid measures power export to or import from grid. Positive value means the power feeds into grid, negative value means the power used from the grid.

Press up and down button to review the parameter, press "ESC" to return to Status .

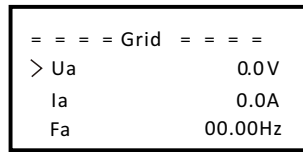

b) Solar

This status shows the real time PV condition of the system, such as input voltage, current and power situation of each PV input. Press up and down button to review parameter, Press "ESC" to return to Status.

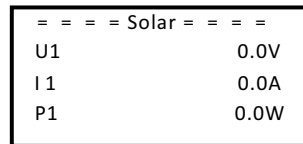

c) Load

If the inverter is plugged in a smart plug, this status shows the real time load power, include load1 power and load 2 power. Press up and down button to review parameter, Press "ESC" to return to Status.

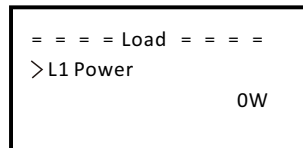

● Settings

Setting function is used for setting the inverter for time, connection, Grid and so on.

Since this function will change the inverter's parameter, the end user with the user password as "0000" has the limited authority to change the setting. We need installer password to do most of the professional setting.

Password

The default password is "0000" for end user, which only allows the user to review the current setting and some easy setting. If professional change is needed, please contact with the distributor or factory for installer password. We need to increase or decrease the word by pressing up or down button. Press OK to confirm an alternate to the next word. After word is confirmed, press "OK" to enter password.

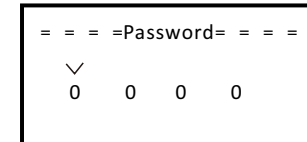

Setting

If inputting the installer password, the information of the LCD interface is as below.

a) Safety

The user can set the safety standard here. According to different countries and grid tied standards. There is several standards for choice (May change without notice.)

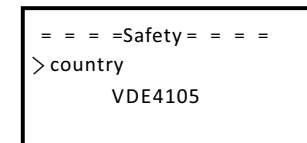

Item	Standard	Country	Item	Standard	Country
1	As4777	Australia	3	IEC 61727	India
2	En50438	Netherland	4	VDE 4105	German

b) Date time

This interface is for user to set the system date and time. Increase or decrease the word by pressing up or down button. Press OK to confirm and alternate to next word. After all the words are confirmed. Press "OK" to enter the date and time.

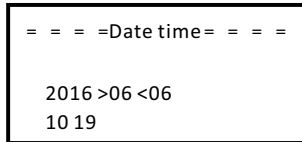

c) New Password

Installer can set the new password here. We need to increase or decrease the word by pressing up or down button. Press OK to confirm and alternate to next word. After word is confirmed., press "OK" to reset the password.

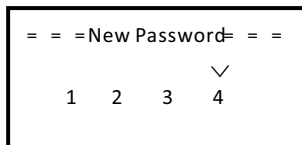

d) Export control

With this function the inverter can control energy exported to the grid. Whether having this function is based on user's wishes.

Choose "Enable" in "Enable/Disable" means user must install a meter to monitor energy exported to the grid. There are user value and factory value. The factory value is default which can not be changed by user. The user value setting by installer must be less than the factory value and within the range of 0KW to 20KW.

Choose "Disable" means the function will be shut off.

Press up and down button to select and press "OK" to confirm.

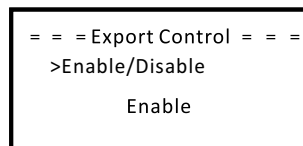

e) RF Control

RF Control is an optional function which can control designated load intelligently by consuming the surplus energy when feed in power reaches certain value.

For specific operation, please refer to "Load remote control installation guide".

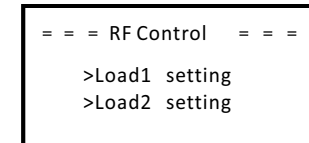

f) DRM Function

User can choose whether using the DRM function or not.

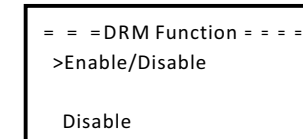

g) Line Impedance

If able is choosen, the inverter will identify actively the impedance between the inverter and grid, and reduce the effect on input port of the inverter. This function is disable by default.

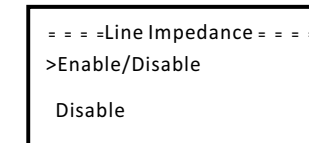

h) Grid Services

Usually end user do not need to set the grid parameters. All default value have been set before leaving factory according to safety rules.

If need to reset, any changes should according to the requirement of local grid.

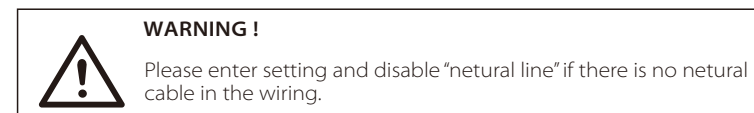

1. **==== P(freq) ====**
Enable/Disable
>Disable <

If need to reset, any changes should according to the requirement of local grid.

2. **==== Soft start ====**
Enable/Disable
>Disable <

If need to reset, any changes should according to the requirement of local grid.

3. **==== ConditionConn ====**
Enable/Disable
>Disable <

If need to reset, any changes should according to the requirement of local grid.

4-1. **==== Reactive Power ====**
Mode Selection
>Off <

If need to reset, any changes should according to the requirement of local grid.

Mode	Comment
Off	-
Under-Excited	PF value
Over-Excited	PF value
PF(P)	Upper limit
	Lower limit
	Power Upper
	Power Lower
Q(u)	Q(u) Range V1 (AS4777)
	Q(u) Range V4 (AS4777)
	Q(u) V Up Rate (EN50438_NL)
	Q(u) V Low Rate (EN50438_NL)
Fix Q Power	Q Power

4-2. **Reactive power control, Reactive standard curve $\cos \varphi = f(P)$**

For VDE ARN 4105, curve $\cos \varphi = f(P)$ should refer to curve A. default values of setting are as shown in curve A.
 For E 8001, curve $\cos \varphi = f(P)$ should refer to curve B. default values of setting are as shown in curve B.

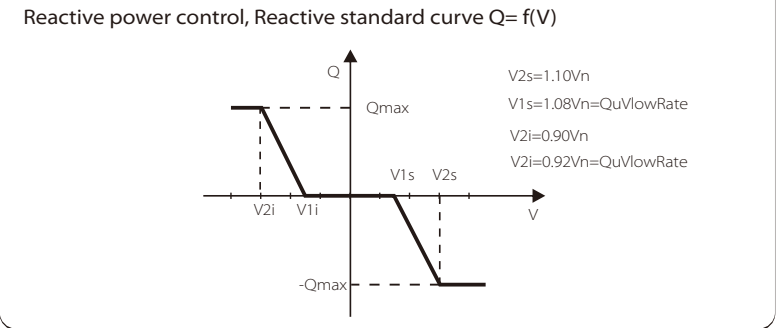
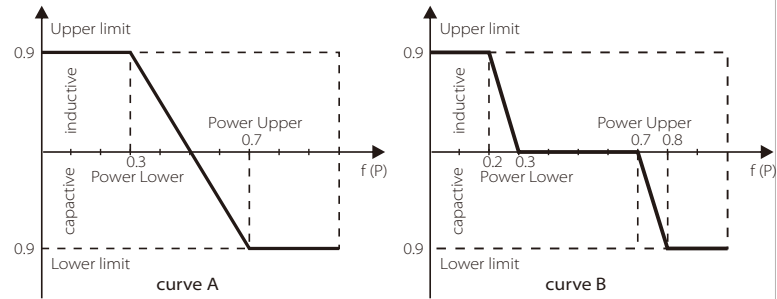

5. **==== P(u) Function ====**
Enable/Disable
>Enable <

The device is suitable for Australia if the "Enable" is chosen.

6. **==== Power Limits ====**
>Proportion
1.00

User can set the power limit here, the setting value is from 0.00-1.00.

j) Grid Protection

Usually end user do not need to set the grid Protection. All default value have been set before leaving factory according to safety rules.
If need to reset, any changes should according to the requirement of local grid.

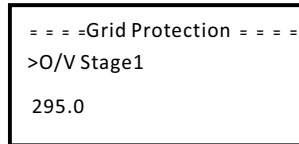

k) Energy Reset

User can reset the energy record here. Press up or down button to select and press "OK" to confirm.

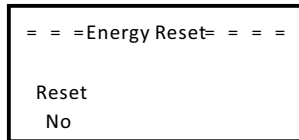

l) Load Reset

Reset consume is to reset load, user can reset the load if the inverter is plugged in a smart plug. Press up or down button to select and press "ok" to confirm.

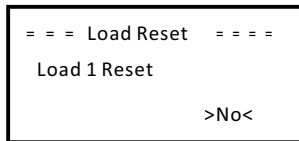

m) Meter Reset

User can reset the meter. Press up or down button to select and press "ok" to confirm. (User can Select "Yes" to reset meter if user purchase SolaX meter)

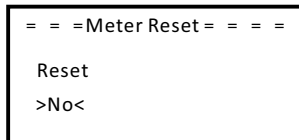

n) Errorlogs Reset

User can reset the error log here. Press up or down button to select and press "OK" to confirm.

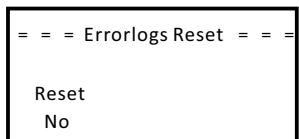

o) Start guide

This interface makes user set initial setting of the inverter again possible.

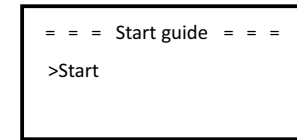

● History

The history function contains four aspects of the information: Inverter yield, load consume, Meter and error logs.
Press up and down to select ,and press "OK" to confirm the selection, press "ESC" to return to Menu.

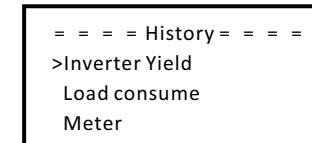

a) Inverter Yield

The inverter yield function contains energy generated by today, yesterday ,this month ,last month and total.
Press up and down button to review the parameter, Press "ESC" to return to history.

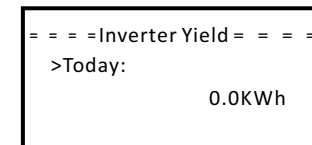

b) Load consume

User can check the load consumption if the device is plugged in a smart plug.

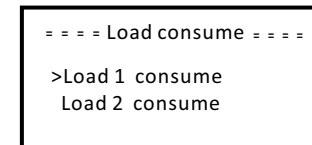

c) Meter

This function is made user check meter energy possible. (Meter energy will show if user use SolaX meter)

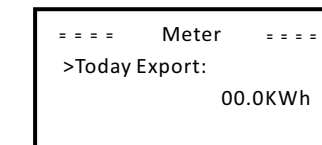

d) Error logs

The Error log contains error information happened, It can record for six items.

Press up and down button to review parameter, Press“ESC” to return to History.

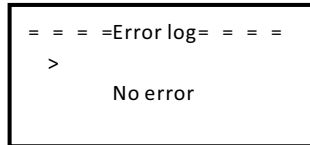

● About

This interface shows information of the inverter, include serial number, product SN, machine type, master, slave and manager.

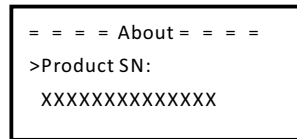

7. Troubleshooting

7.1 Trouble shooting

This section contains information and procedures for solving possible problems with X3 series inverters, and provides you with troubleshooting tips to identify and solve most problems that could occur with the X3 series inverters.

This section will help you narrow down the source of any problems you may encounter. Please read the following troubleshooting steps.

Check warnings or fault messages on System Control Panel or Fault codes on the inverter information panel. If a message is displayed, record it before doing anything further.

Attempt the solution indicated in below table.

Faults	Diagnosis and solution
SPI Fault	SPI communication fault -Disconnect PV+ and PV-, reconnect them -Or seek help form us, if can not go back to normal state
SCI Fault	SCI communication fault -Disconnect PV+ and PV-, reconnect them -Or seek help form us, if can not go back to normal state
PVConfigset_Wrong	PV connection setting fault -Disconnect PV+ and PV-, reconnect them -Or seek help form us, if can not go back to normal state
EEPROM_WR_Fault	EEPROM reading or writing fault -Disconnect PV+ and PV-, reconnect them -Or seek help form us, if can not go back to normal state
Relay Fault	Relay Fault -Disconnect PV+ and PV-, reconnect them -Or seek help form us, if can not go back to normal state
Sample Fault	Grid voltage or frequency sampling Fault -Disconnect PV+ and PV-, reconnect them -Or seek help form us, if can not go back to normal state
RCD Fault	Residual Current Device Fault -Check the impedance of DC input and AC output. -Disconnect PV+ and PV-, reconnect them -Or seek help form us, if can not go back to normal state
Grid Lost Fault	Grid is Lost -System will reconnect if the utility is back to normal. -Or seek help from us.
TZ Protect Fault	Over Current Fault -Wait for a while to check if go back to normal status -Disconnect PV+ and PV-, reconnect them -Or seek help form us, if can not go back to normal state
Grid Volt Fault	Grid Voltage Out of Range -System will reconnect if the utility is back to normal. -Or seek help from us.
Grid Freq Fault	Grid Frequency Out of Range -System will reconnect if the utility is back to normal. -Or seek help from us.
Bus Volt Fault	Bus Voltage Out of Normal Range -Disconnect PV+,PV-,reconnect them. -Check if the PV input is within the range of the inverter. -Or seek help from us,if can not go back to normal state.

Inv OCP Fault	Inverter over current protection fault -Wait for a while to check if back to normal. -Or seek help from us.
DCI OCP Fault	DCI over current protection Fault -Wait for a while to check if back to normal. -Or seek help from us.
PV Volt Fault	PV Voltage Fault -Check the connection of the inverter. -Or seek help from us.
Isolation Fault	Isolation Fault -Check the connection of the inverter. -Or seek help from us.
Temp Over Fault	Temp over the limitation -Check if the environment temperature is over limitation. -Or seek help from us.
RC Fault	Residual current over the limition -Wait for a while to check if back to normal. -Or seek help from us.
SW OCP Fault	Over Current Fault detected by software -Wait for a while to check if go back to normal status. -Or seek help form us.
RTC Fault	RTC Fault -Turn off the PV and grid,reconnect them. -Or seek help form us.
Mgr EEPROM Fault	Manager EEPROM Fault -Turn off the PV and grid,reconnect them. -Or seek help form us.
Meter Fault	Meter Fault -Check if the meter is connected properly. -Check if the meter set normally. -Or seek help form us.
Other device Fault	Other device Fault -Turn off the PV and grid,reconnect them. -Or seek help form us.
AC10M Volt Fault	AC10Minute overvoltage Fault System will reconnect if the utility is back to normal. Or seek help from us.

- If your inverter's information panel is not displaying a Fault light, check the following list to make sure that the present state of the installation allows proper operation of the unit.
 - Is the inverter located in a clean, dry, adequately ventilated place?
 - Have the DC input breakers been opened?
 - Are the cables adequately sized and short enough?
 - Are the input and output connections and wiring in good condition?
 - Are the configurations settings correct for your particular installation?
 - Are the display panel and the communications cable properly connected and undamaged?

Contact SolaX Customer Service for further assistance. Please be prepared to describe details of your system installation and provide model and serial number of the unit.

7.2 Routine maintenance

Inverters do not need any maintenance or correction in most condition, but if the inverter often loses power due to overheating, this can be the following reason:

- The cooling fins on the rear of house are covered by dirt. Clean the cooling fins with a soft dry cloth or brush if necessary.
- Only trained and authorized professional personnel who are familiar with the requirements of safety was allowed to perform servicing and maintenance work.**

► Safety checks

Safety checks should be performed at least every 12 months by manufacturer's qualified person who has adequate training, knowledge, and practical experience to perform these tests. The data should be recorded in an equipment log. If the device is not functioning properly or fails any of test, the device has to be repaired. For safety check details, refer to this manual, section 2 Safety instruction and EC Directives.

► Maintain periodically

Only qualified person may perform the following works. During the process of using the inverter, the manage person shall examine and maintain the machine regularly. The concrete operations are follow.

- 1: Check that if the cooling fins on the rear of house are covered by dirt, and the machine should be cleaned and absorbed dust when necessary. This work shall be check time to time.
- 2: Check that if the indicators of the inverter are in normal state, check if the keys of the inverter are in normal state, check if the display of the inverter is normal. This check should be performed at least every 6 months.
- 3: Check that if the input and output wires are damaged or aged. This check should be performed at least every 6 months.
- 4: You should get the inverter panels cleaned and their security checked at least every 6 months.

8. Decommissioning

8.1 Dismantling the Inverter

- Disconnect the inverter from DC Input and AC output.
- Wait for 5 minutes for de-energizing.
- Disconnect communication and optional connection wirings.
- Remove the inverter from the bracket.
- Remove the bracket if necessary.

8.2 Packaging

If possible, please pack the inverter with the original packaging.

If it is no longer available, you can also use an equivalent carton that meets the following requirements.

- Suitable for loads more than 30 kg.
- With handle.
- Can be fully closed.

8.3 Storage and Transportation

Store the inverter in dry place where ambient temperatures are always between -25 °C - +60 °C. Take care of the inverter during the storage and transportation, keep less than 4 cartons in one stack.

When the inverter or other related components need to be disposed. Have it carried out according to local waste handling regulations. Please be sure to deliver wasted inverters and packing materials to certain site, where can assist relevant department to dispose and recycle.